



## SL 1008 OUTDOOR

LIFTS UP TO 1,000 KG / 2,200 LBS.

The SL 1008 Outdoor is our most advanced lift. It combines maximum lifting power and reach. Large window sections are easily and precisely handled using the multifunctional, rotary yoke.

The wireless remote controls all functions and offers freedom of movement for the operator. A display gives the operator full overview of battery status, vacuum level and actual load strain. The lift has a proportional hydraulic system that enables the operator to control the arm extremely precisely so that small adjustments of the controls trigger small movements of the yoke and arm.

The SL 1008 Outdoor is fitted with wide twin tyres to prevent the machine from getting bogged down. The lift is front-wheel driven and fitted with wide tyres to ensure unique stability when driving with a full load.

 Available in all colors



EXTENSION OF ARM  
**1.66 M** / 66 IN.



LIFTING HEIGHT  
**4.4 M** / 173 IN.



The flagship of the Smart Lift line that also features hydraulic yoke rotation



**SMARTLIFT®**

**BASIC DATA (PROVISIONAL)**

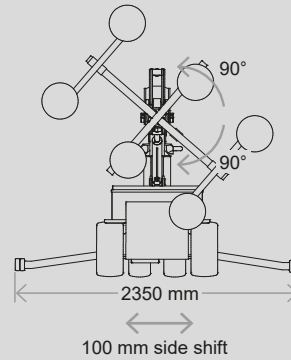
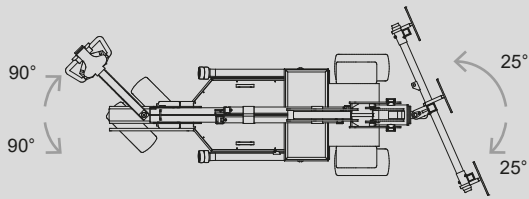
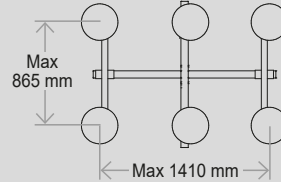
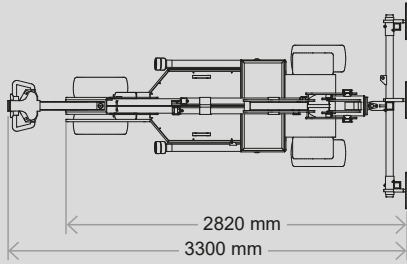
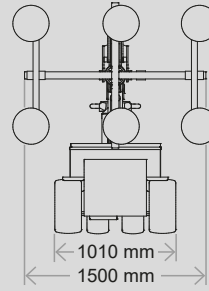
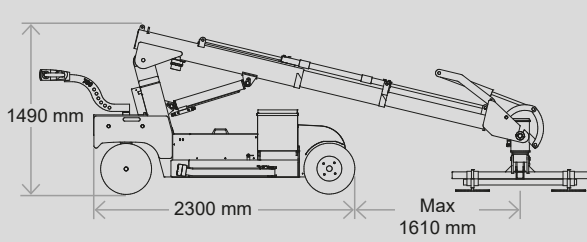

**TECHNICAL SPECIFICATIONS**

Lifting cap. arm in/out	1,000 / 280 kg - 2,200 / 620 lbs.
Lifting height	4,400 mm / 173 in.
Extension of arm	2 x 830 mm / 2 x 33 in.
Tip from horizontal	42° back / 86° fwd
Side shift	100 mm / 4 in
Charging voltage	230V / 110V
Charging time	Approx. 8 hrs.
Battery	4 x 134 Ah AGM
Running period	Up to 8 hrs.
Front wheel drive	2000 W AC
Suction pads	6 x Ø400mm / Ø16 in.
Curb weight	1,300 kg / 2,866 lbs.
Class	IP 65

**LOAD DIAGRAM**

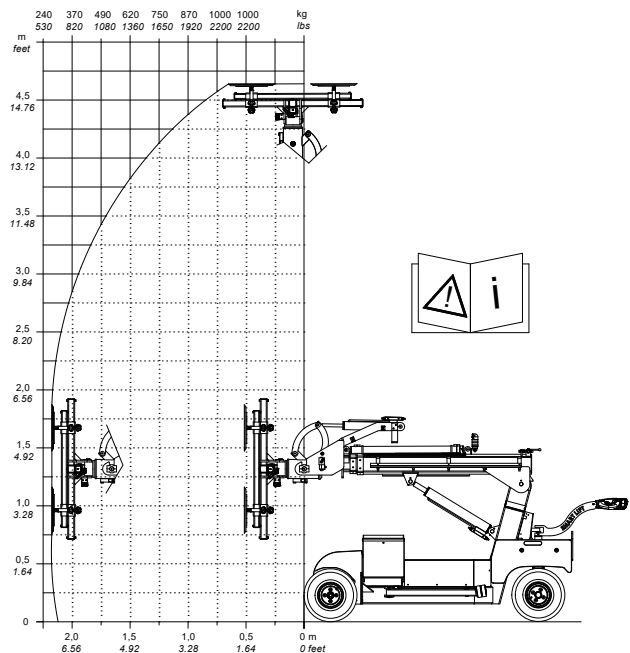

**SMARTLIFT®**

www.smartlift.com